

**HPT**  
European Standard Profile For Cooling



## HPT, the european standard quick coupling system for low pressure applications

## HPT, das Europrofil Kupplungssystem für Niederdruckanwendungen

### Characteristics / Eigenschaften

- One-hand connection
- High quality materials
- Compact and ergonomic design
- Available in stainless steel
- Available as Multicoupling
- Einhandbedienung
- Hochwertige Materialien
- Kompaktes und ergonomisches Design
- In Edelstahl erhältlich
- Als Multikupplung erhältlich

### High temperature option "HT" / Hochtemperatur Option "HT"

The HT option contains a high performance sealing - developed for special requirement of high temperature applications.  
Heat resistance up to 220° - Heatingoil: 220°C and Water: 180°C.

Die HT-Option enthält eine Hochleistungsichtung, welche für die besonderen Anforderungen von Hochtemperaturanwendungen entwickelt wurde.  
Hitzebeständig bis 220°C - Wärmeträgeröl: 220°C und Heisswasser: 180°C.

### Disconnecting lock / Entkupplungssperre

All couplings are available with the "disconnecting lock" safety feature this prevents the coupling system from unintentionally disconnecting.

Alle Kupplungen sind mit dem Sicherheitsmerkmal - "Entkupplungssperre" erhältlich, welches das ungewollte Entkoppeln des Kupplungssystems verhindert.



HPT  
COOLING STANDART



## FLEXQ Series HPT

-- PROFILE EUROPE --

Options / Optionen		Using areas / Einsatzbereiche
<ul style="list-style-type: none"> <li>Color coding / Farbkodierung</li> <li>Stainless Steel / Edelstahl</li> <li>Safety locking / Sicherheitsverriegelung</li> <li>High Temperature / Hochtemperaurdichtung</li> </ul>	R / B VA S  HT	<ul style="list-style-type: none"> <li>Cooling heating / Temperierung</li> <li>Injection moulding / Kunststoffindustrie</li> </ul>

Materials / Materialien			
Body Socket	Brass	Kupplungskörper	Messing
Body Plug	Brass	Stecker	Messing
Sleeve	Brass	Hülse	Messing
Valve	Brass	Ventil	Messing
Locking Ring	Stainless steel	Sprengring	Edelstahl
Spring	Stainless steel	Feder	Edelstahl
Balls	Stainless steel	Kugeln	Edelstahl
Seals	Viton (V)	Dichtungen	Viton (V)

Temperature range / Temperaturbereich		
Nitril (NBR)	N	-15 °C +100 °C
Fluor Carbon (FPM)	V	-20 °C +160 °C (Water / Wasser) -20 °C +200 °C (Heating Oil / Wärmeträgeröl)
High performance Fluor Carbon (FPM)	HT	-20 °C +180 °C (Water / Wasser) -20 °C +220 °C (Heating Oil / Wärmeträgeröl)

	HPT 06	HPT 09	HPT 13
Flow Size / Nennweiten	6	9	13
Pressure / Druck	10	15	15



Always make sure no medium flows before disconnecting / Stellen Sie immer vor dem Trennen sicher, dass kein Medium fließt

### FLEXQ Serie HPT Flow Rate & Pressure Drop Graph / Durchfluss- und Druckabfalldiagramm

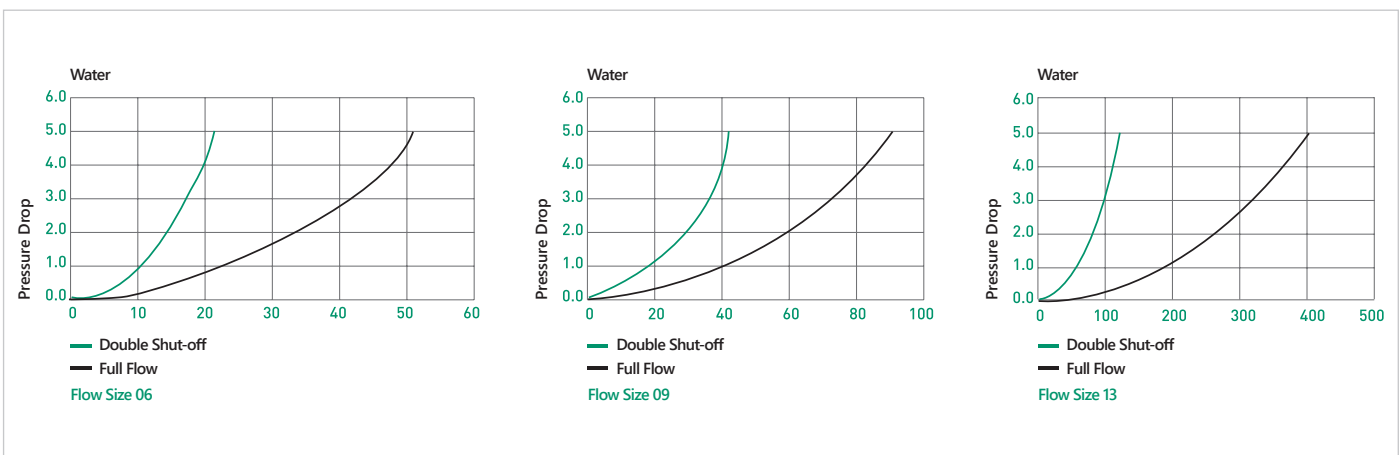

Size			Ød	Ød1	L	L1
6	HPT 06 FHB 06	HPT 06 FHF 06	06	18	49	20
	HPT 06 FHB 09	HPT 06 FHF 09	09	18	49	20
	HPT 06 FHB 13	HPT 06 FHF 13	13	18	49	20
9	HPT 09 FHB 09	HPT 09 FHF 09	09	23	59	23
	HPT 09 FHB 13	HPT 09 FHF 13	13	23	59	25
13	HPT 13 FHB 16	HPT 13 FHF 16	16	32	90	32
	HPT 13 FHB 19	HPT 13 FHF 19	19	32	90	32

**Standard hose tail socket**  
Kupplung mit gerader Standard - Schlauchtülle

[VIEW ONLINE](#)

Size			Ød	Ød1	L	L1
6	HPT 06 FPB 06	HPT 06 FPF 06	06	18	55	24
	HPT 06 FPB 10	HPT 06 FPF 10	10	18	55	24
	HPT 06 FPB 13	HPT 06 FPF 13	13	18	58	28
9	HPT 09 FPB 10	HPT 09 FPF 10	10	23	60	28
	HPT 09 FPB 13	HPT 09 FPF 13	13	23	64	28
13	HPT 13 FPB 16	HPT 13 FPF 16	16	32	97	38
	HPT 13 FPB 19	HPT 13 FPF 19	19	32	97	38

**Clampless hose tail socket**  
Kupplung mit gerader Schnellsteck - Schlauchtülle

[VIEW ONLINE](#)

Size			Ød	Ød1	L	L1
6	HPT 06 FHB 06-45	HPT 06 FHF 06-45	06	18	42	19
	HPT 06 FHB 09-45	HPT 06 FHF 09-45	09	18	42	19
	HPT 06 FHB 13-45	HPT 06 FHF 13-45	13	18	42	19
9	HPT 09 FHB 09-45	HPT 09 FHF 09-45	09	23	52	24
	HPT 09 FHB 13-45	HPT 09 FHF 13-45	13	23	52	26
13	HPT 13 FHB 16-45	HPT 13 FHF 16-45	16	32	82	34
	HPT 13 FHB 19-45	HPT 13 FHF 19-45	19	32	82	34

**Standard hose tail socket 45°**  
Kupplung mit 45° Standard - Schlauchtülle

[VIEW ONLINE](#)

Size			Ød	Ød1	L	L1
6	HPT 06 FPB 06-45	HPT 06 FPF 06-45	06	18	41	24
	HPT 06 FPB 10-45	HPT 06 FPF 10-45	10	18	41	24
	HPT 06 FPB 13-45	HPT 06 FPF 13-45	13	18	41	28
9	HPT 09 FPB 10-45	HPT 09 FPF 10-45	10	23	52	24
	HPT 09 FPB 13-45	HPT 09 FPF 13-45	13	23	52	28
13	HPT 13 FPB 16-45	HPT 13 FPF 16-45	16	32	88	38
	HPT 13 FPB 19-45	HPT 13 FPF 19-45	19	32	88	38

**Clampless hose tail socket 45°**  
Kupplung mit 45° Schnellsteck - Schlauchtülle

[VIEW ONLINE](#)

**Standard hose tail socket 90°  
Kupplung mit 90° Standard - Schlauchtülle**

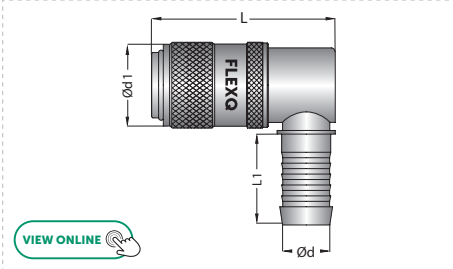

Size				Ød	Ød1	L	L1
6	HPT 06 FHB 06-90	HPT 06 FHF 06-90		06	18	41	21
	HPT 06 FHB 09-90	HPT 06 FHF 09-90		09	18	41	21
	HPT 06 FHB 13-90	HPT 06 FHF 13-90		13	18	41	23
9	HPT 09 FHB 09-90	HPT 09 FHF 09-90		09	23	52	24
	HPT 09 FHB 13-90	HPT 09 FHF 13-90		13	23	52	26
13	HPT 13 FHB 16-90	HPT 13 FHF 16-90		16	32	88	33
	HPT 13 FHB 19-90	HPT 13 FHF 19-90		19	32	88	34

**Clampless hose tail socket 90°  
Kupplung mit 90° Schnellsteck - Schlauchtülle**

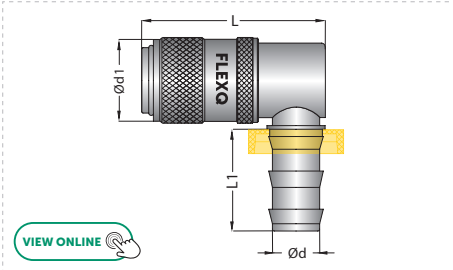

Size				Ød	Ød1	L	L1
6	HPT 06 FPB 06-90	HPT 06 FPF 06-90		06	18	41	24
	HPT 06 FPB 10-90	HPT 06 FPF 10-90		10	18	41	24
	HPT 06 FPB 13-90	HPT 06 FPF 13-90		13	18	41	28
9	HPT 09 FPB 10-90	HPT 09 FPF 10-90		10	23	52	24
	HPT 09 FPB 13-90	HPT 09 FPF 13-90		13	23	52	28
13	HPT 13 FPB 16-90	HPT 13 FPF 16-90		16	32	88	38
	HPT 13 FPB 19-90	HPT 13 FPF 19-90		19	32	88	38

**Cylindrical male thread socket  
Kupplung mit Aussengewinde zylindrisch**

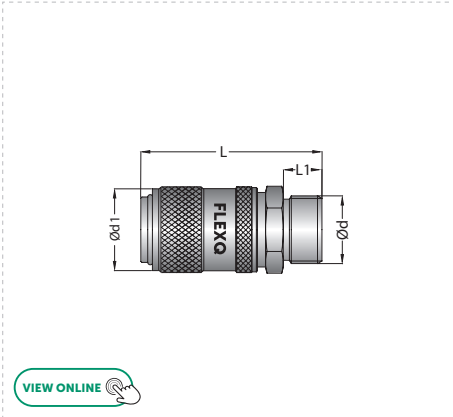

Size				Ød	Ød1	L	L1	HEX
6	HPT 06 FMB 14	HPT 06 FMF 14		BSP 1/4	18	47	11	17
	HPT 06 FMB 38	HPT 06 FMF 38		BSP 3/8	18	47	11	19
	HPT 06 FMB 1415	HPT 06 FMF 1415		M14x1.5	18	47	11	17
	HPT 06 FMB 1615	HPT 06 FMF 1615		M16x1.5	18	48	11	19
9	HPT 09 FMB 14	HPT 09 FMF 14		BSP 1/4	23	52	11	21
	HPT 09 FMB 38	HPT 09 FMF 38		BSP 3/8	23	52	11	21
	HPT 09 FMB 12	HPT 09 FMF 12		BSP 1/2	23	52	14	22
	HPT 09 FMB 1615	HPT 09 FMF 1615		M16x1.5	23	52	11	21
13	HPT 13 FMB 12	HPT 13 FMF 12		BSP 1/2	32	75	14	30
	HPT 13 FMB 34	HPT 13 FMF 34		BSP 3/4	32	77	16	30
	HPT 13 FMB 2415	HPT 13 FMF 2415		M24x1.5	32	77	16	30

**Cylindrical male thread socket 45°  
Kupplung mit 45° Aussengewinde zylindrisch**

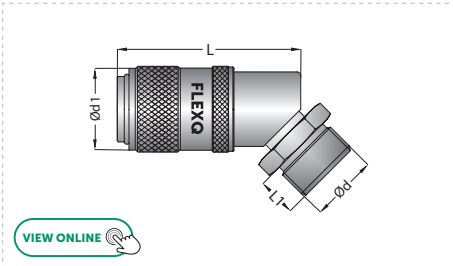

Size				ØD	ØD1	L	L1	HEX
6	HPT 06 FMB 14-45	HPT 06 FMF 14-45		BSP 1/4	18	43	11	14
	HPT 06 FMB 38-45	HPT 06 FMF 38-45		BSP 3/8	18	43	11	17
	HPT 06 FMB 1415-45	HPT 06 FMF 1415-45		M14x1.5	18	43	11	17
	HPT 06 FMB 1615-45	HPT 06 FMF 1615-45		M16x1.5	18	43	11	17
9	HPT 09 FMB 38-45	HPT 09 FMF 38-45		BSP 3/8	23	52	11	17
	HPT 09 FMB 1615-45	HPT 09 FMF 1615-45		M16x1.5	23	52	11	17
13	HPT 13 FMB 2415-45	HPT 13 FMF 2415-45		M24x1.5	32	88	16	24

Size			Ød	Ød1	L	L1	HEX
6	HPT 06 FMB 14-90	HPT 06 FMF 14-90	BSP 1/4	18	43	11	14
	HPT 06 FMB 38-90	HPT 06 FMF 38-90	BSP 3/8	18	43	11	17
	HPT 06 FMB 1415-90	HPT 06 FMF 1415-90	M14x1.5	18	43	11	17
	HPT 06 FMB 1615-90	HPT 06 FMF 1615-90	M16x1.5	18	43	11	17
9	HPT 09 FMB 38-90	HPT 09 FMF 38-90	BSP 3/8	23	52	11	17
	HPT 09 FMB 1615-90	HPT 09 FMF 1615-90	M16x1.5	23	52	11	17
13	HPT 13 FMB 2415-90	HPT 13 FMF 2415-90	M24x1.5	32	88	16	24

Cylindrical male thread socket 90°  
Kupplung mit 90° Aussengewinde zylindrisch

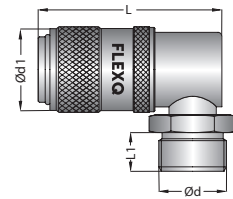

[VIEW ONLINE](#)

Size			Ød	Ød1	L	HEX
6	HPT 06 FFB 14	HPT 06 FFF 14	BSP 1/4	18	47	17
	HPT 06 FFB 38	HPT 06 FFF 38	BSP 3/8	18	47	19
	HPT 06 FFB 1415	HPT 06 FFF 1415	M14x1.5	18	47	17
9	HPT 09 FFB 14	HPT 09 FFF 14	BSP 1/4	32	48	21
	HPT 09 FFB 38	HPT 09 FFF 38	BSP 3/8	32	48	21
	HPT 09 FFB 12	HPT 09 FFF 12	BSP 1/2	32	51	24
13	HPT 09 FFB 1615	HPT 09 FFF 1615	M16x1.5	32	28	21
	HPT 13 FFB 34	HPT 13 FFF 34	BSP 3/4	32	77	30

Cylindrical female thread socket  
Kupplung mit Innengewinde zylindrisch

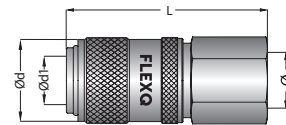

[VIEW ONLINE](#)

Size		Without Valve / Ohne Ventil	Ød	Ød1	Ød2	L	L1	L2
6		HPT 06 FCF 125	6	18	8x1	44	125	2
		HPT 06 FCF 250	6	18	8x1	44	250	2
		HPT 06 FCF 500	6	18	8x1	44	500	2
9		HPT 09 FCF 125	9	23	10x1	52	125	2
		HPT 09 FCF 250	9	23	10x1	52	250	2
		HPT 09 FCF 500	9	23	10x1	52	500	2
13		HPT 13 FCF 160	13	32	14x1	80	160	3
		HPT 13 FCF 315	13	32	14x1	80	315	3
		HPT 13 FCF 500	13	32	14x1	80	500	3

Diverting sockets / Umlenkcupplung

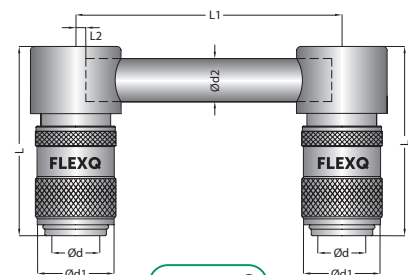

[VIEW ONLINE](#)

Includes 2 sockets and pipe / Beinhaltet 2 Kupplungen und das Verbindungsrohr

Size		Without Valve / Ohne Ventil	Ød	Ød1	Ød2	Ød3	L	L3
6		HPT 06 FCF	9	18	8x1	20	44	37
9		HPT 09 FCF	13	23	10x1	26	52	43
13		HPT 13 FCF	19	32	14x1	36	80	65

Diverting sockets / Umlenkcupplung

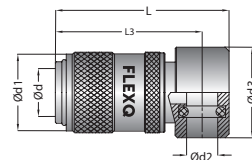

[VIEW ONLINE](#)

Size	Brass Tube Messing Rohr	Ød	Ød1	Length / Länge
6	CBM 0810x1000	8	6	1000 mm
9	CBM 1010x1000	10	8	1000 mm
13	CBM 1410x1000	14	12	1000 mm

Pipe / Verbindungsrohr

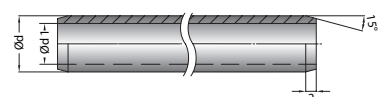

[VIEW ONLINE](#)

Cylindrical male thread socket short version Kupplung mit Aussengewinde zylindr. kurze Version		Size			Ød	Ød1	L	L1	HEX
	6	HPT 06 FMB 14x38	HPT 06 FMF 14x38	BSP 1/4	18	38	9	17	
	9	HPT 09 FMB 38x38	HPT 09 FMF 38x38	BSP 3/8	23	38	9	21	

[VIEW ONLINE](#)

Adapting Socket with plug / Adapterkupplung mit Nippel		Size			Ød	Ød1	Ød2	Ød3	L	max.flow
	6	HPT 06 FXB HPT 06	HPT 06 FXF HPT 06	6	9	18	9	46	6	
	6	HPT 06 FXB HPT 09	HPT 06 FXF HPT 09	9	13	18	9	46	9	
	9	HPT 09 FXB HPT 06	HPT 09 FXF HPT 06	6	9	23	13	50.3	6	
	9	HPT 09 FXB HPT 09	HPT 09 FXF HPT 09	9	13	23	13	50.3	9	
	6	HPT 06 FXB IPT 06	HPT 06 FXF IPT 06	6	9.5	18	9	43	6	
	6	HPT 06 FXB IPT 09	HPT 06 FXF IPT 09	9	13.5	18	9	45	9	
	9	HPT 09 FXB IPT 06	HPT 09 FXF IPT 06	6	9.5	23	13	52	6	
	9	HPT 09 FXB IPT 09	HPT 09 FXF IPT 09	9	13.5	23	13	52	9	

[VIEW ONLINE](#)

Blind Socket / Blindkupplung		Size	Order No / Bestellnr.	Ød	L
	6	HPT 06 FB	18	34	
	9	HPT 09 FB	23	40	
	13	HPT 13 FB	32	58	

[VIEW ONLINE](#)

Blind Plug / Blindnippel		Size	Order No / Bestellnr.	Ød	L
	6	HPT 06 MB	9	29	
	9	HPT 09 MB	13	31	
	13	HPT 13 MB	19	51	

[VIEW ONLINE](#)

Adapting Plug / Adapternippel		Size		Ød	Ød1	L
	6	HPT 06 MXM HPT 06	9	9	34	
	6	HPT 06 MXM HPT 09	9	13	38	
	9	HPT 09 MXM HPT 09	13	13	40	
	9	HPT 09 MXM IPT 06	13	9.5	38	
	9	HPT 09 MXM IPT 09	13	13.5	40	

[VIEW ONLINE](#)

Size			ØD	Ød1	L	L1	HEX	Male thread plug / Nippel mit Aussengewinde
6	HPT 06 MMF 18	BSP 1/8	9	24	7	11		
	HPT 06 MMF 14	BSP 1/4	9	26	9	14		
	HPT 06 MMF 38	BSP 3/8	9	26	9	17		
	HPT 06 MMF 1010	M10x1	9	24	7	11		
	HPT 06 MMF 1015	M10x1.5	9	25	8	11		
	HPT 06 MMF 1215	M12x1.5	9	27	9	17		
	HPT 06 MMF 12175	M12x1.75	9	27	9	14		
	HPT 06 MMF 1415	M14x1.5	9	26	9	15		
	HPT 06 MMF 1615	M16x1.5	9	26	9	17		
	HPT 06 MRF 18	BSPT 1/8	9	26	9	11		
	HPT 06 MRF 14	BSPT 1/4	9	30	12	14		
	HPT 06 MRF 38	BSPT 3/8	9	30	13	17		
9	HPT 09 MMF 18	BSP 1/8	13.5	24	7	14		
	HPT 09 MMF 14	BSP 1/4	13.5	26	9	14		
	HPT 09 MMF 38	BSP 3/8	13.5	26	9	17		
	HPT 09 MMF 12	BSP 1/2	13.5	30	12	21		
	HPT 09 MMF 1010	M10x1.0	13.5	24	7	14		
	HPT 09 MMF 1015	M10x1.5	13.5	26	9	14		
	HPT 09 MMF 12175	M12x1.75	13.5	29	9	14		
	HPT 09 MMF 1415	M14x1.5	13.5	26	9	15		
	HPT 09 MMF 1615	M16x1.5	13.5	26	9	17		
	HPT 09 MRF 14	BSPT 1/4	13.5	31	12	14		
	HPT 09 MRF 38	BSPT 3/8	13.5	31	13	17		
	HPT 09 MRF 12	BSPT 1/2	13.5	36	16	22		
	HPT 09 MRF 34	BSPT 3/4	13.5	40	18	27		
13	HPT 13 MMF 12	BSP 1/2 BSP	19	47	12	22		
	HPT 13 MMF 34	3/4	19	51	16	27		
	HPT 13 MMF 10	BSP 1	19	53	17	35		
	HPT 13 MMF 2415	M24x1.5	19	51	16	27		

[VIEW ONLINE](#)

Size			Ød	Ød1	L	L1	Standard hose tail plug Nippel mit gerader Standard - Schlauchtülle
6	HPT 06 MHF 06	6 mm	9	37	19		
	HPT 06 MHF 09	9 mm	9	37	19		
	HPT 06 MHF 13	13 mm	9	43	25		
9	HPT 09 MHF 09	9 mm	13.5	40	24		
	HPT 09 MHF 13	13 mm	13.5	41	24		
13	HPT 13 MHF 16	16 mm	19	54	24		
	HPT 13 MHF 19	19 mm	19	61	32		

[VIEW ONLINE](#)

**Cylindrical male thread plug inner hex. / Nippel mit Aussengewinde zylindrisch Innensechskant**

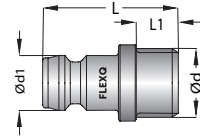
**Inner HEX**

[VIEW ONLINE](#)

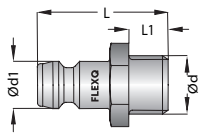
Size		Ød	Ød1	L	L1	HEX
6	HPT 06 MMFH 14	BSP 1/8	9	24	7	5
	HPT 06 MMFH 14	BSP 1/4	9	27	9	5
	HPT 06 MMFH 0875	M8x075	9	24	8	5
	HPT 06 MMFH 1010	M10x1	9	24	8	5
	HPT 06 MMFH 1415	M14x1.5	9	27	9	5
9	HPT 09 MMFH 18	BSP 1/8	13.5	24	7	7
	HPT 09 MMFH 14	BSP 1/4	13.5	26	9	7
	HPT 09 MMFH 38	BSP 3/8	13.5	26	9	7
	HPT 09 MMFH 1010	M10x1.5	13.5	26	9	7
	HPT 09 MMFH 12175	M12x1.75	13.5	26	9	7
	HPT 09 MMFH 1415	M14x1.5	13.5	26	9	7

**Cylindrical male thread plug with valve Verschlussnippel mit Aussengewinde zylindrisch**

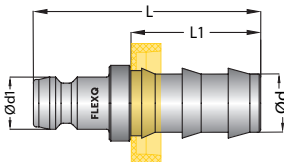
[VIEW ONLINE](#)

Size		Ød	Ød1	L	L1	HEX
6	HPT 06 MMB 14	BSP 1/4	9	28	11	14
	HPT 06 MMB 38	BSP 3/8	9	28	11	17
	HPT 06 MMB 1415	M14x1.5	9	28	11	14
9	HPT 09 MMB 14	BSP 1/4	13	29	12	14
	HPT 09 MMB 38	BSP 3/8	13	30	12	17
	HPT 09 MMB 12	BSP 1/2	13	31	12	21
	HPT 09 MMB 1415	M14x1.5	13	30	12	15
	HPT 09 MMB 1615	M16x1.5	13	30	12	17
13	HPT 13 MMB 12	BSP 1/2	19	47	15	22
	HPT 13 MMB 34	BSP 3/4	19	51	15	27
	HPT 13 MB 2415	M24x1.5	19	51	17	27

**Clampless hose tail plug Nippel mit gerader Schnellsteck - Schlauchtülle**

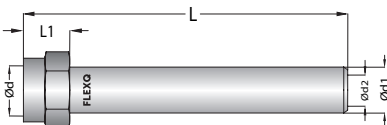
[VIEW ONLINE](#)

Size		Ød	Ød1	L	L1
6	HPT 06 MPF 10	10 mm	9	44	24
	HPT 06 MPF 13	13 mm	9	45	28
9	HPT 09 MPF 10	10 mm	13.4	43	24
	HPT 09 MPF 13	13 mm	13.5	47	28
13	HPT 13 MPF 16	16 mm	19	70	38
	HPT 13 MPF 19	19 mm	19	70	38

**Extension / Verlängerung**

Size		Ød	Ød1	Ød2	L	L1	HEX
6	FEN 14-120	BSP 1/4	10	6	120	11	17
9	FEN 38-150	BSP 3/8	14	9	150	11	22
6	FEN 1415-120	M14x1.5	10	6	120	12	17
9	FEN 1615-120	M16x1.5	14	9	150	12	22

Size		$\varnothing d$	$\varnothing d1$	L	L1	L2	HEX
6	HPT 06 MRF 18-90	BSPT 1/8	9	27	9	23.5	11
	HPT 06 MRF 14-90	BSPT 1/4	9	27	11	27.5	15
	HPT 06 MMF 0875-90	M8x0.75	9	27	9	23.5	11
	HPT 06 MMF 1010-90	M10x1	9	27	9	23.5	11
	HPT 06 MMF 1415-90	M14x1.5	9	34	11	27.5	15
9	HPT 09 MRF 18-90	BSPT 1/8	13	34	9	24.5	15
	HPT 09 MRF 14-90	BSPT 1/4	13	34	11	24.5	15
	HPT 09 MMF 1415-90	M14x1.5	13	34	11	24.5	15
13	HPT 13 MRF 12-90	BSPT 1/2	19	41	15	42	25
	HPT 13 MMF 2415 -90	M24x1.5	19	41	16	42	25

Male thread plug 90° / Nippel mit Aussengewinde 90° (Metric DIN 158 - Conical DIN 2999)

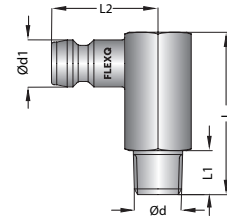

[VIEW ONLINE](#)

Size		$\varnothing d$	$\varnothing d1$	L	HEX
6	HPT 06 MFF 18	BSP 1/8	9	23	13
	HPT 06 MFF 14	BSP 1/4	9	27	17
	HPT 06 MFF 38	BSP 3/8	9	27	19
9	HPT 09 MFF 14	BSP 1/4	13	26	17
	HPT 09 MFF 38	BSP 3/8	13	27	19
	HPT 09 MFF 12	BSP 1/2	13	30	24
13	HPT 13 MFF 12	BSP 1/2	19	44	24
	HPT 13 MFF 34	BSP 3/4	19	50	30

Cylindrical female thread plug / Nippel mit Innengewinde zylindrisch

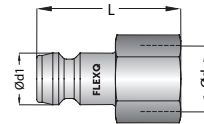

[VIEW ONLINE](#)

Size		$\varnothing d$	$\varnothing d1$	L	L1	HEX
6	HPT 06 MMFL 18x100	BSP 1/8	9	100	6x10	11
	HPT 06 MMFL 14x100	BSP 1/4	9	100	6x10	14
	HPT 06 MMFL 38x100	BSP 3/8	9	100	6x10	17
	HPT 06 MMFL 1010x100	M10x1.0	9	100	6x10	11
	HPT 06 MMFL 1415x100	M14x1.5	9	100	6x10	14
9	HPT 09 MMFL 14x100	BSP 1/4	13	100	6x10	14
	HPT 09 MMFL 38x100	BSP 3/8	13	100	6x10	17
	HPT 09 MMFL 1415x100	M14x1.5	13	100	6x10	14
	HPT 09 MMFL 1615x100	M16x1.5	13	100	6x10	17

Male long thread plug / Nippel mit langem Aussengewinde zylindrisch

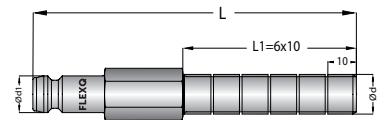

[VIEW ONLINE](#)

Plug extension / Nippelverlängerung		Size		Ød	Ød1	L	L1	HEX
	6	HPT 06 MEF 63		8	9	63	21	9
		HPT 06 MEF 100-08		8	9	100	21	9
		HPT 06 MEF 100-10		10	9	100	21	11
		HPT 06 MEF 120		10	9	120	21	11
		HPT 06 MEF 240		10	9	240	21	11
		HPT 06 MEF 360		10	9	360	21	11
	9	HPT 09 MEF 50		14	13	50	22	15
		HPT 09 MEF 100		14	13	100	22	15
		HPT 09 MEF 120		14	13	120	22	15
		HPT 09 MEF 150-08		14	13	150	22	15
		HPT 09 MEF 300		14	13	300	22	15
		HPT 09 MEF 450		14	13	450	22	15
	13	HPT 13 MEF 500		21	19	500	35	22
		HPT 13 MEF 800		21	19	800	35	22

[VIEW ONLINE](#)

Male thread extension plug / Nippelverlängerung mit Aussengewinde		Size		Ød	Ød1	L	L1	L2	HEX
	6	HPT 06 MRF 18xL		BSPT 1/8	9	*	21	7	11
		HPT 06 MRF 14xL		BSPT 1/4	9	*	22	9	14
		HPT 06 MMF 0875xL		M8x0.75	9	*	21	7	11
		HPT 06 MMF 1010xL		M10x1.0	9	*	21	7	11
		HPT 06 MMF 1015xL		M14x1.5	9	*	21	9	11

[VIEW ONLINE](#)

\* L : Lenght (mm): 50 / 80 / 100 / 120 / 150 / 200

Male thread extension plug / Nippelverlängerung mit Aussengewinde		Size		Ød	Ød1	L	L1	L2	HEX
	9	HPT 09 MRF 14xL		BSPT 1/4	13.5	*	22	9	14
		HPT 09 MRF 38xL		BSPT 3/8	13.5	*	22	9	17
		HPT 09 MMF 18xL		BSP 1/8	13.5	*	22	7	14
		HPT 09 MMF 14xL		BSP 1/4	13.5	*	22	9	14
		HPT 09 MMF 38xL		BSP 3/8	13.5	*	22	9	17
		HPT 09 MMF 08125xL		M8x1.25	13.5	*	22	9	14
		HPT 09 MMF 1010xL		M10x1.0	13.5	*	22	10	14
		HPT 09 MMF 1015xL		M10x1.5	13.5	*	22	10	14
		HPT 09 MMF 1215xL		M12x1.5	13.5	*	22	10	14
		HPT 09 MMF 12175xL		M12x1.75	13.5	*	22	10	14
		HPT 09 MMF 1415xL		M14x1.5	13.5	*	22	10	15
		HPT 09 MMF 1420xL		M14x2.0	13.5	*	22	10	15
		HPT 09 MMF 1615xL		M16x1.5	13.5	*	22	13	17
HPT 09 MMF 1620xL		M16x2.0	13.5	*	22	13	17		

[VIEW ONLINE](#)

\* L : Lenght (mm): 50 / 80 / 100 / 120 / 150 / 200

Size		Description	Material	Working Temp.
6	SK HPT 06 MN	Plug Seal Kit	NBR - Nitrile	-15°C +100°C
9	SK HPT 09 MN	Plug Seal Kit	NBR - Nitrile	-15°C +100°C
13	SK HPT 13 MN	Plug Seal Kit	NBR - Nitrile	-15°C +100°C
6	SK HPT 06 FN	Socket Seal Kit	NBR - Nitrile	-15°C +100°C
9	SK HPT 09 FN	Socket Seal Kit	NBR - Nitrile	-15°C +100°C
13	SK HPT 13 FN	Socket Seal Kit	NBR - Nitrile	-15°C +100°C
6	SK HPT 06 MV	Plug Seal Kit	FPM - Viton	-20°C +200°C
9	SK HPT 09 MV	Plug Seal Kit	FPM - Viton	-20°C +200°C
13	SK HPT 13 MV	Plug Seal Kit	FPM - Viton	-20°C +200°C
6	SK HPT 06 FV	Socket Seal Kit	FPM - Viton	-20°C +200°C
9	SK HPT 09 FV	Socket Seal Kit	FPM - Viton	-20°C +200°C
13	SK HPT 13 FV	Socket Seal Kit	FPM - Viton	-20°C +200°C

Replacement seal set / Ersatz O-Ring Set

[VIEW ONLINE](#)

VALVES